

USER MANUAL

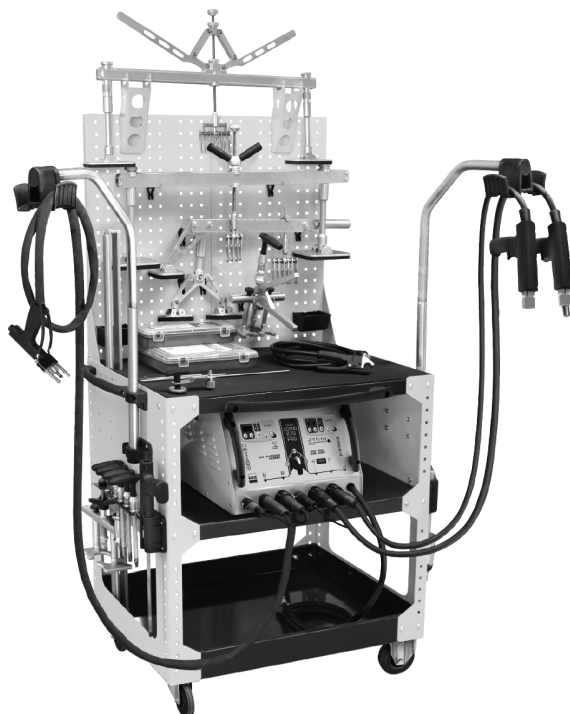







GYSLINER • GYSLINER 39.02 • GYSLINER 39.04 GYSLINER PRO 230 • GYSLINER PRO 400 GYSLINER COMBI 230 PRO

SUMMARY

ASSEMBLY	2
COMPOSITION	3
STRAIGHTENING LEVER AND BARS	3
Choose your bar or your lever	3
Choose the right straightening process	4
Examples of application	6
MAGNETIC EARTH.....	6
MANUSPOT	6
Connections of the different tools.....	6
Universal dent pulling clamp.....	7
Pulling handles	8
Contact shrinking tool.....	8
Easy Gun	8
MINI PULLER	8

ASSEMBLY

M8 x 16  X51	M6 x 10  X21	M6 x 20  X22	M8 x 45  X4	M6  X43	M8  X55
--	--	--	---	---	---

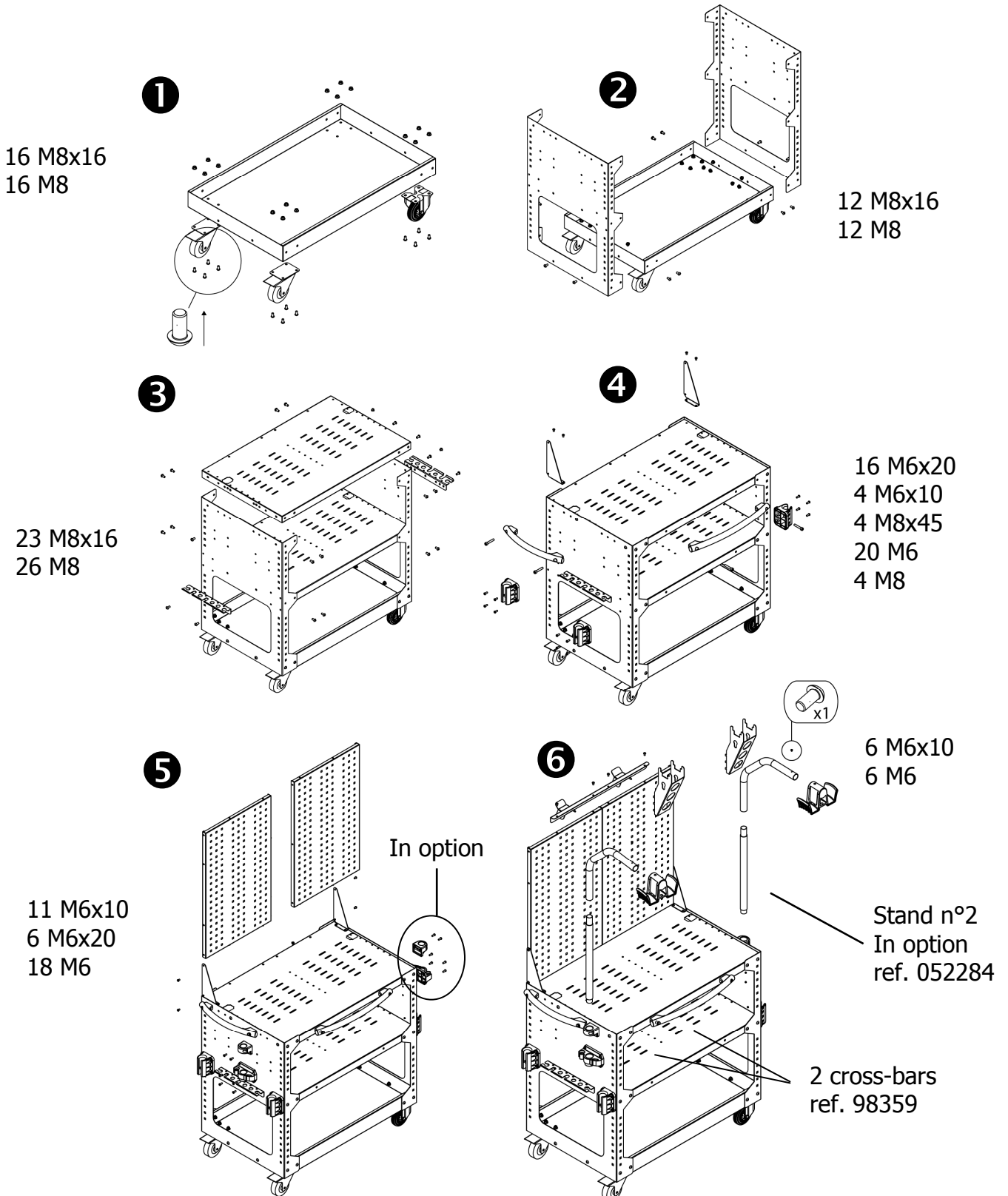

COMPOSITION

COMBI 230 PRO / 39.02 / 39.04 / PRO 230 / PRO 400

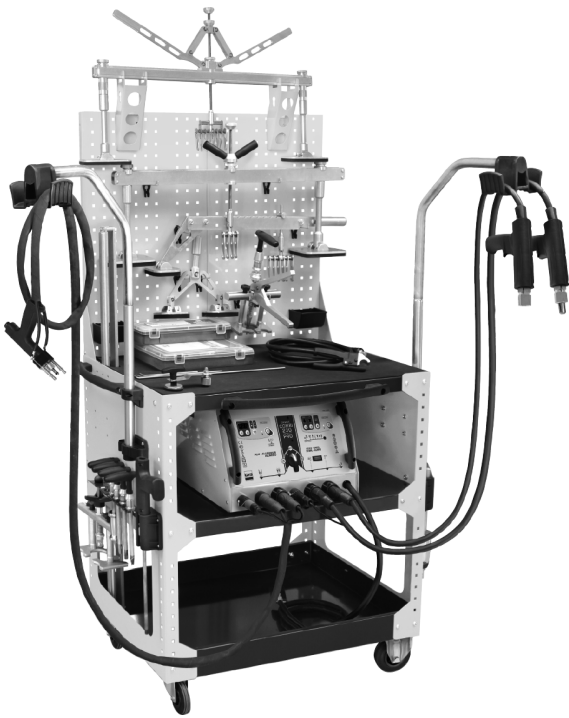

XXXXX	Generator	1
050747	Workstation	1
050679	Manuspot (with Easy gun)	1
050686	Straightening lever	1
050693	Straightening bar 80 cm	1
050716	Pulling bar	1
050723	Double pats kit	1
051171	Re-inforcing Bar 1200 mm	1
050792	3 traction rods	1
049758	Hooks 4 claws	1
049734	Hooks 6 claws	1
049741	Hooks 8 claws	1
049666	Steel magnetic mass	1
051515	Box of steel consumables	1
052451	Set of 2x 55mm extension joints	1

+ COMBI 230 PRO ONLY

052284	Stand for dent puller	1
050921	Mini puller	1
050945	Alu hook 2	1
050051	Inertia hammer for glue puller	1
050938	Alu hook 1	1
051683	Alu earth gun	1

STRAIGHTENING LEVER AND BAR

CHOOSE YOUR BAR OR YOUR LEVER



Straightening lever
ref.050686



For areas when the sheets are thin. Ex: door, fender...

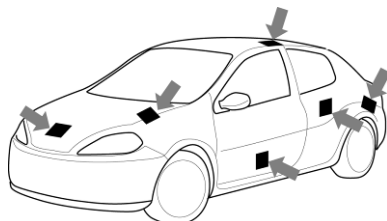
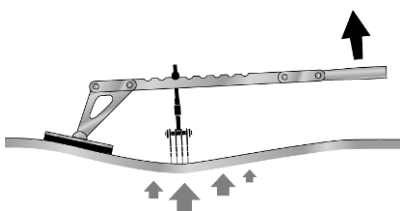

Straightening bar
ref.050693



To straighten or maintain a sheet under stress after using the pulling bar

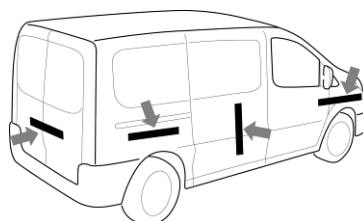
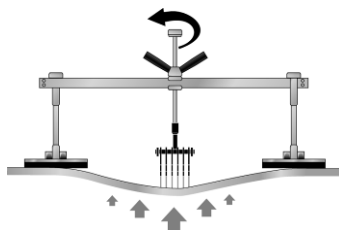

Pulling bar
ref.050716

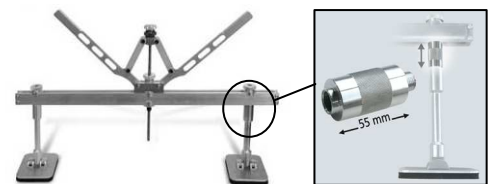

To straighten or maintain a sheet under stress after using the pulling bar

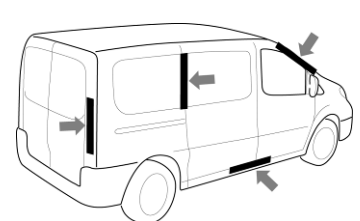
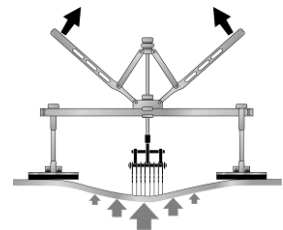

For angles and rounded corners

Change the original pads for the double ones (ref.050723)



Adaptable on:

- Straightening bar
- Pulling bar

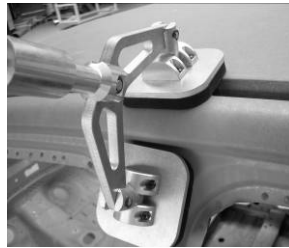

For wide areas (ex. utility vehicle side panel)

Replace the original traction bar (0,8m) by the 1,2 m bar (ref.050730)

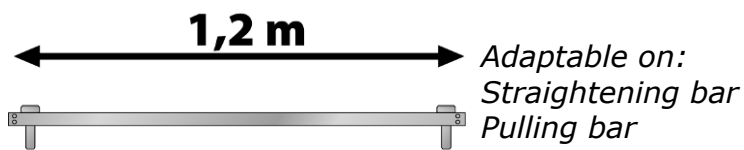

Exemple of application:

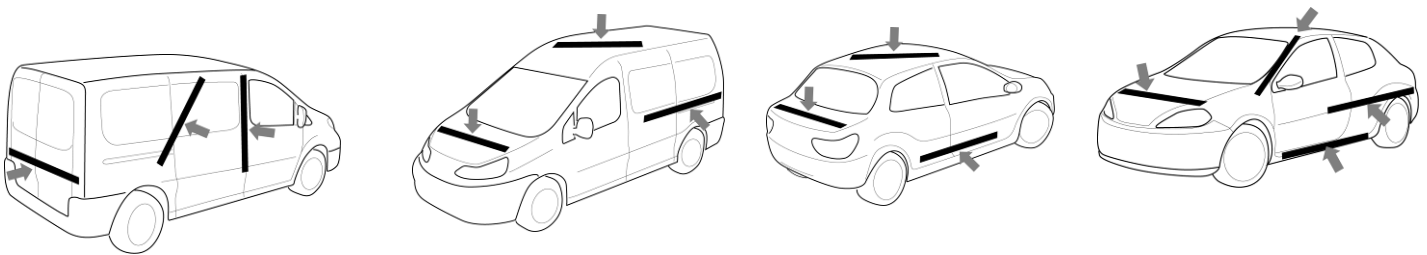

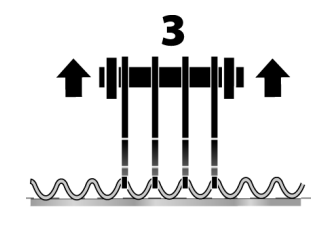
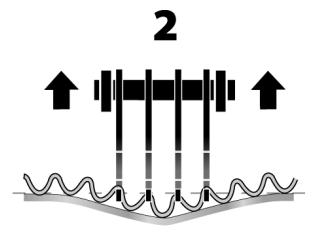
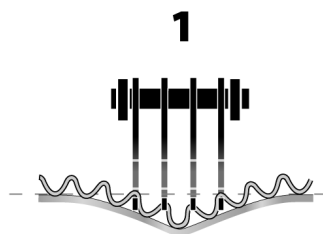
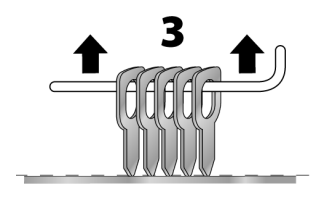
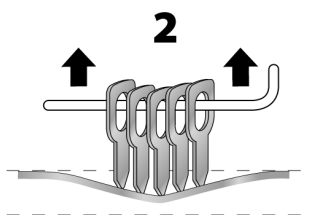
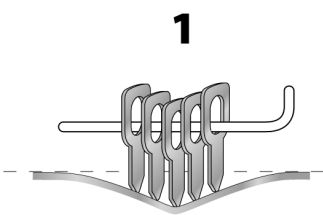

CHOOSE THE RIGHT STRAIGHTENING PROCESS

Principles





Comparison

Rings or wavy wire?

	 Rings	 Wavy wire <i>x50 ref.049727</i>
Use	To straighten all the bumps, middle to big bumps	To straighten light and middle bumps
Advantages	<ul style="list-style-type: none"> - Versatility - Pulling strength - Ideal for sills 	<ul style="list-style-type: none"> - Fast set-up - Ideal for rounded areas (example : wheel arch ...)
Disadvantages	Long set-up	Standard space between welded points
To be used with	Traction rod + hooks (4 - 6 - 8 claws)	Hooks (4 - 6 - 8 claws)
Possible tools	<ul style="list-style-type: none"> - Lever - Straightening bar - Pulling bar 	<ul style="list-style-type: none"> - Lever - Straightening bar - Pulling bar

Straight or twisted rings?

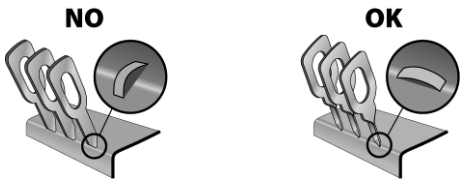
	 Straight rings <i>X100 ref.050648</i>	 Twisted rings <i>X50 ref.050631</i>
Use	To straighten a flat or rounded surface	To pull in the plane of the edge 

Set up:

Rings

To weld the rings, use the ring « accessory welder » of the Manuspot (page 6)



Advice

It is possible to weld the rings at a slight angle and to manually position them vertically afterwards.

When the straightening is finished, twisting the rings will enable to easily remove them.

Wavy wire

To weld the wavy wire, use wavy wire « accessory welder » for Manuspot (page 6)

To unweld the wavy wire, use pliers to move the wire sideways until the weld breaks off.

Note: the rings or wavy wires can be reused, and should only be replaced if worn out.

APPLICATION EXAMPLES

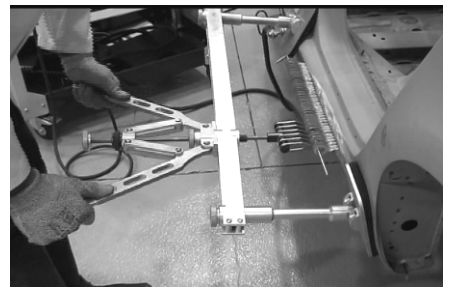
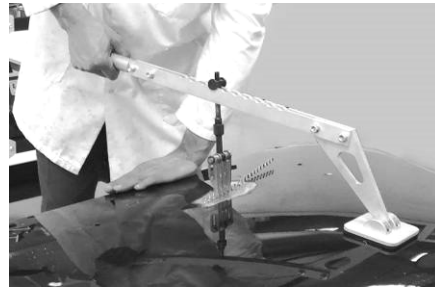
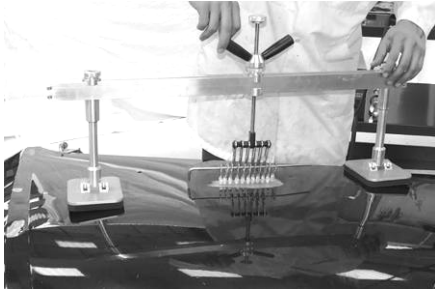

MAGNETIC EARTH

Principle and Application

This system « welded earth » system allows to fix an earth on a small stripped part (less than 2mm against 20mm with a standard earth).

Its magnets allows you to use it in every position (horizontal or vertical)

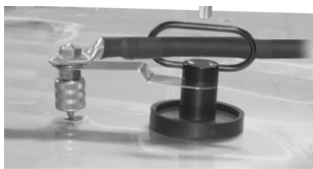

① *Weld the earth thanks to contact shrinking tool (p8)*

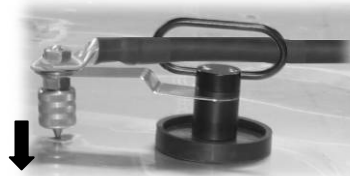

② *Screw the earth to the metal sheet*



MANSPOT ref.050679

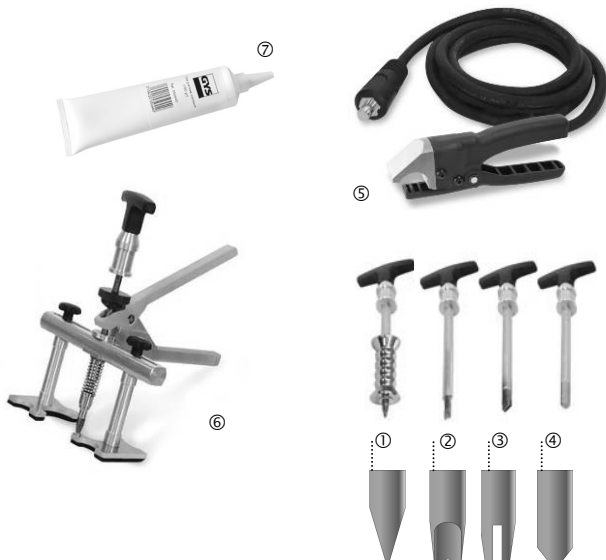

Manuspot: Complete concept including:

- 1 universal dent pulling clamp ⑥
- 1 pulling handle ①
- 2 « accessory welder » tools:
wavy ② + rings ③
- 1 contact shrinking tool ④
- contact clamp with 3m cable ⑤
- copper grease tube ⑦ ref.050440
- 1 Easy Gun

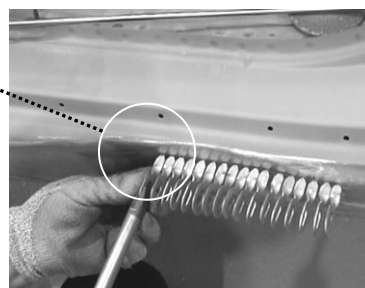
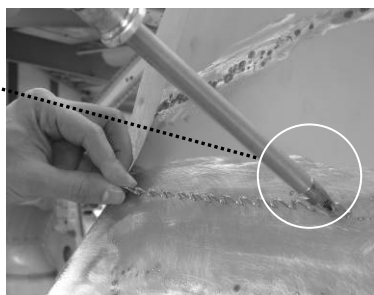
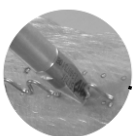

CONNECTION OF DIFERENT TOOLS

Connect the contact clamp as follows:



❶ Connect to the generator



❷ Add copper grease on the inside of the clamp and on the axis of the tool.



❸ Fit the clamp on the tool

II- UNIVERSAL DENT PULLING CLAMP

Principle

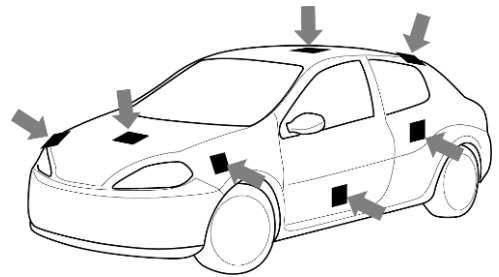
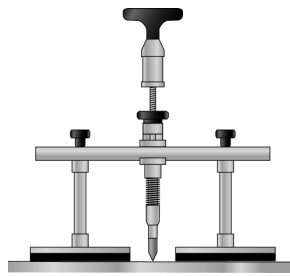
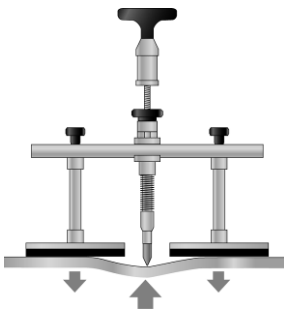

Adjustment and positioning of the pads

❶ Unscrew the nuts on both sides

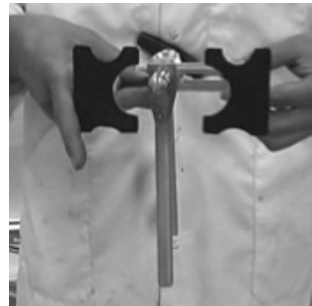
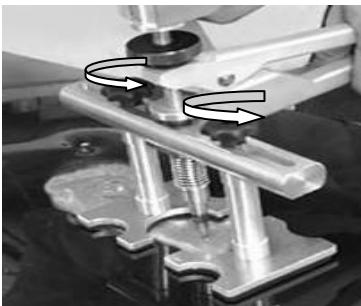

❷ Then choose the position of the pads depending on the area to work on

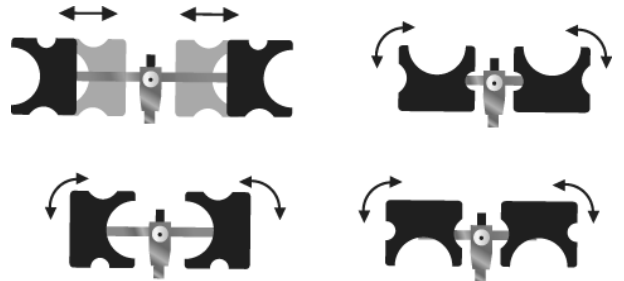

Use

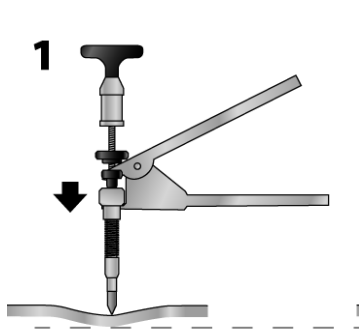

❶ Weld the tip

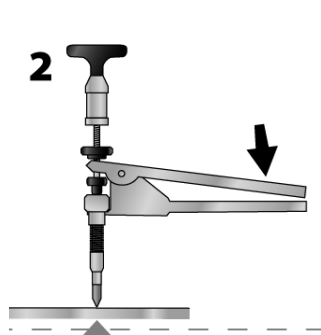

❷ Tighten the handle to dent pull

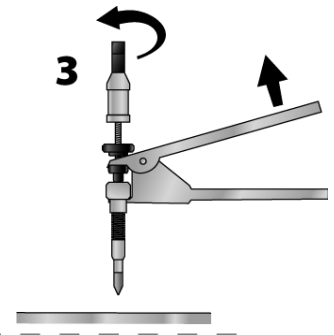

❸ Twist the handle to unwind the tip

Consumables:  3 electrodes for Manuspot handles ref.050822

PULLING HANDLES

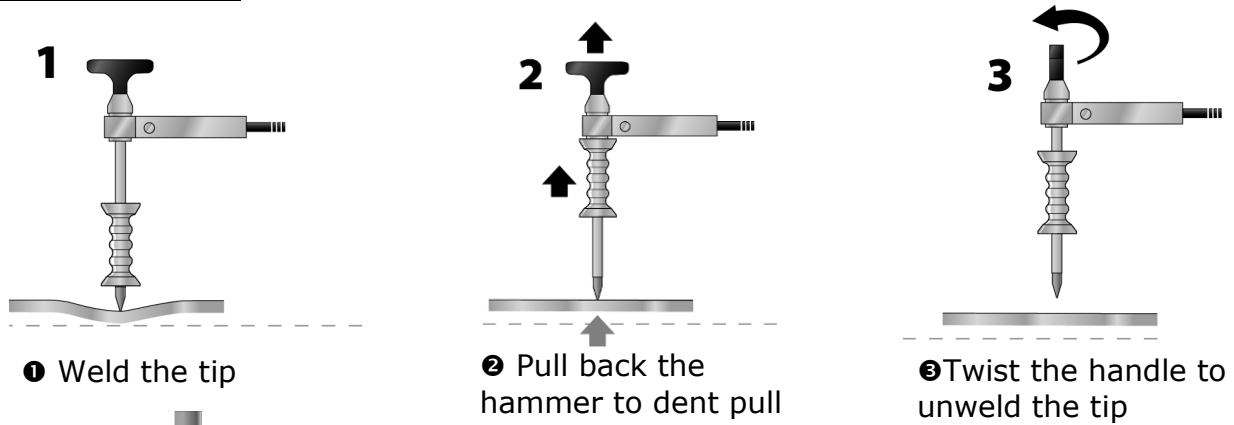

Consommable :  5 électrodes de tirage ref.050839

CONTACT SHRINKING TOOL

Essential tool for the finishing enables to eliminate the spikes created by the dent pulling operations.

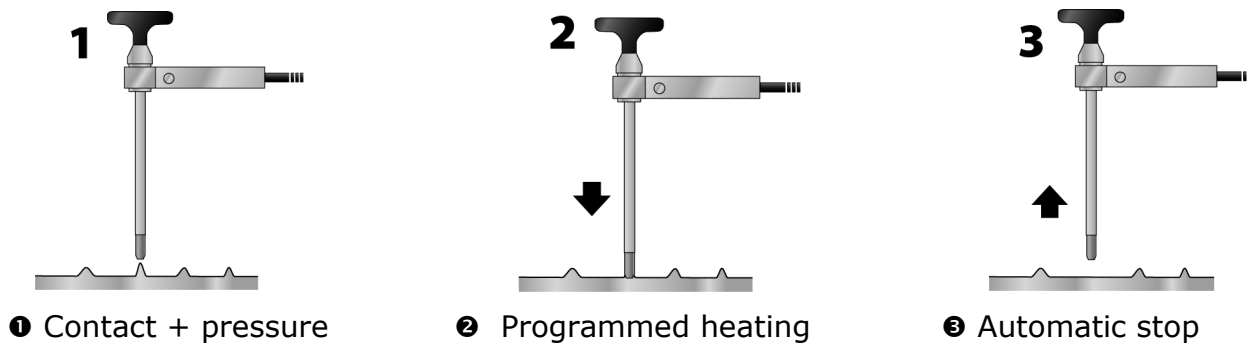

EASY GUN

- 1 Connect the Manuliner contact clamp to the unit.
- 2 Install the tool at the end of the Easy gun then connect the Manuliner contact clamp to the Easy Gun.
- 3 Weld: The welding point is made automatically by a simple contact between the tool and the metal piece to straighten.

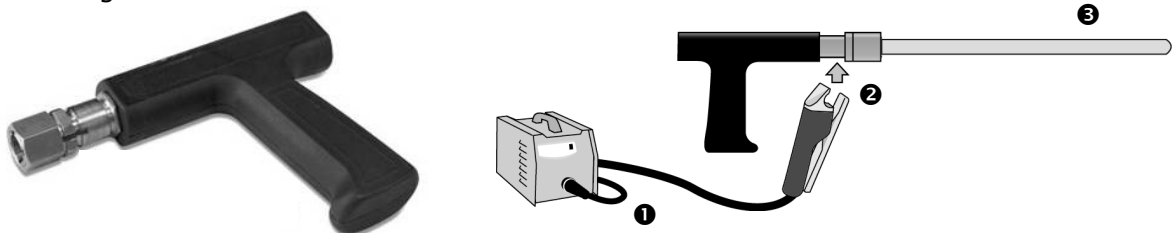

MINI PULLER ref 051003

(+alu hook 1 ref 050938 + alu hook 2 ref 050945)

- 1- Weld the studs to the aluminium sheet with the Combi 230 Pro.
- 2- Fix the hooks on the studs.
- 3- Pull on the hooks with the Mini Puller (diagram)

