

- 1 Zipper MINI
- 2 Zipper initial W
- 3 Zipper final M
- 4 Zipper final D
- 5 Młotek pneumatyczny

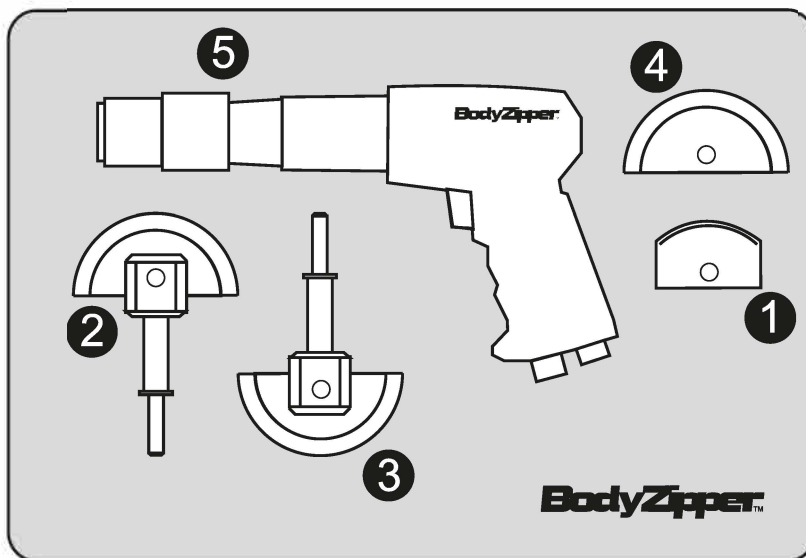

**Coution!** Maximum work pressure 5 bar

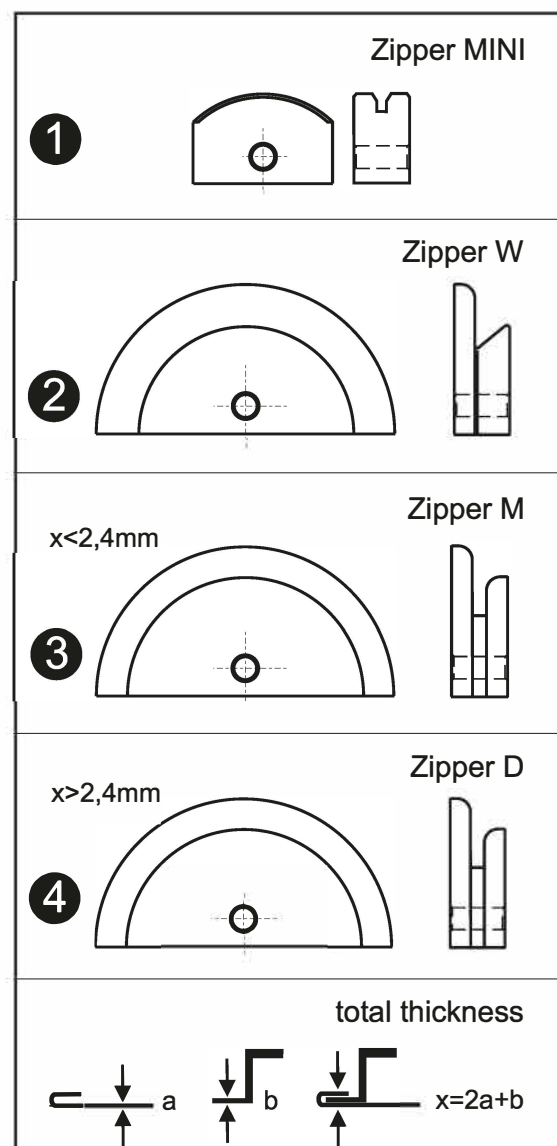
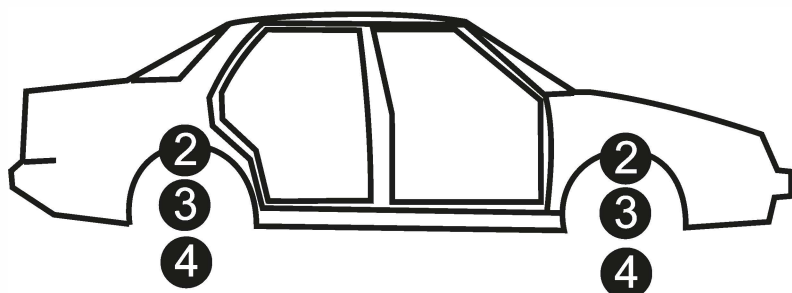
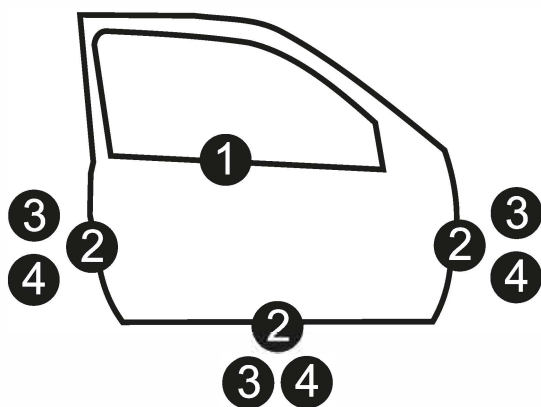

# Instruction

**Coution!** Maximum work pressure 5 bar

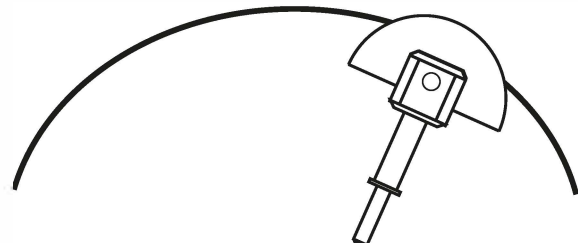
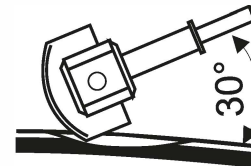
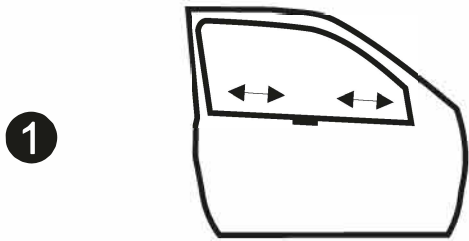
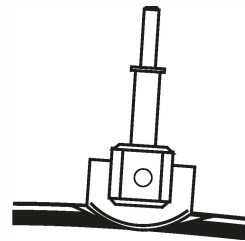
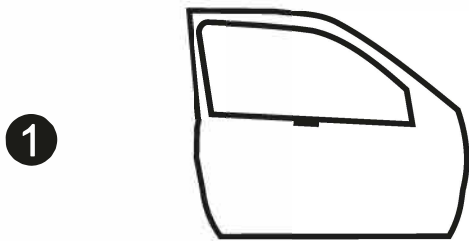
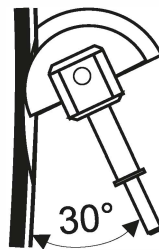
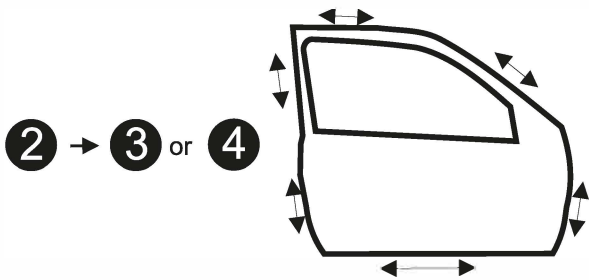
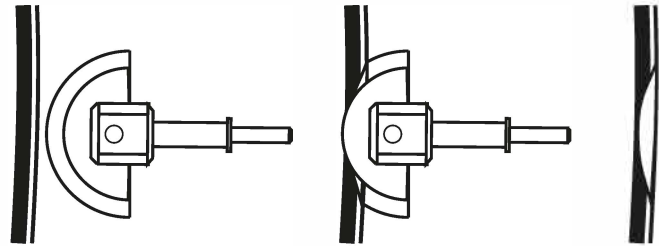
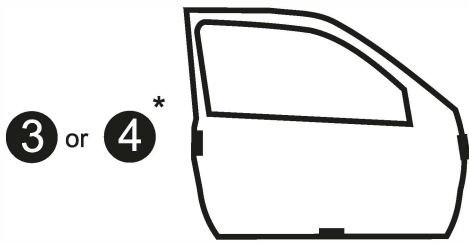
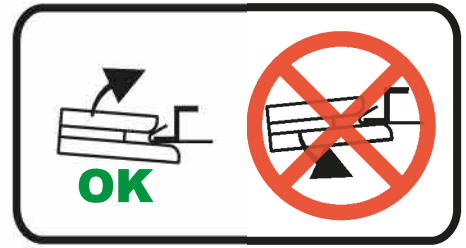

\*Check thickness (x)