



Fabricante Francés  
desde 1964

[www.gys.fr](http://www.gys.fr)



# POSICIONADORES MAGNÉTICOS

Para mayor comodidad al soldar

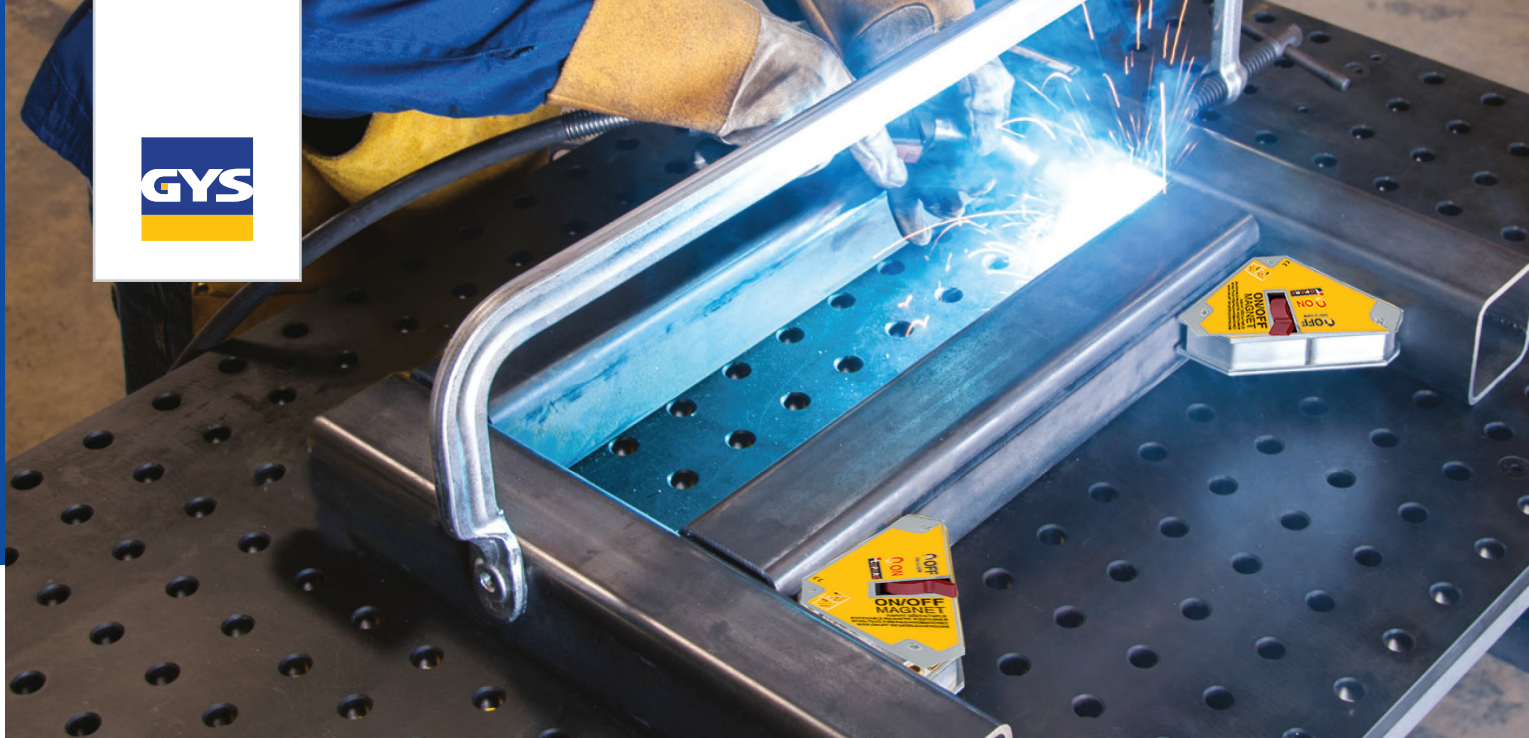

## Posicionadores magnéticos para la comodidad del soldador

### MAGNETIC P 15.90

- Ángulo :  $\sphericalangle$  60° & 90°
- $\text{kg}_{\text{máx}}$  15
- $\text{mm}$  100 x 73 x 12
- $\text{x2}$



047044

### MAGNETIC P 16.90

- Ángulo :  $\sphericalangle$  45°, 90° & 135°
- $\text{kg}_{\text{máx}}$  16
- $\text{mm}$  45 x 32 x 28
- $\text{x4}$

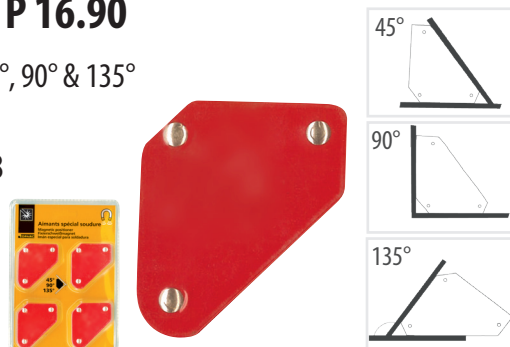

044180

### MAGNETIC P 19.90

- Ángulo :  $\sphericalangle$  45°, 90° & 135°
- $\text{kg}_{\text{máx}}$  19
- $\text{mm}$  156 x 102 x 20
- $\text{x1}$

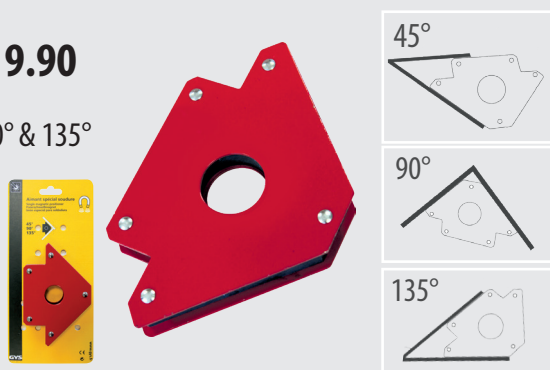

044203



### MAGNETIC P 20.180

- $0 > 180^\circ \sphericalangle$
- $\text{kg}_{\text{máx}}$  20
- $\text{mm}$  204 x 86 x 28
- $\text{x1}$



044302

### MAGNETIC D50.90 DUAL Intercambiable

- Ángulo :  $\sphericalangle$  90°
- $\text{kg}_{\text{máx}}$  50
- $\text{mm}$  148 x 148 x 38
- $\text{x1}$



047051

## MAGNETIC D36.90

Intercambiable

- Ángulo:  $\sphericalangle$  45°, 90° & 135°
- $\overset{\text{máx}}{\text{kg}}$  30 kg
- $\overset{\text{mm}}{\text{mm}}$  111 x 95 x 25
- $\text{x1}$



044197

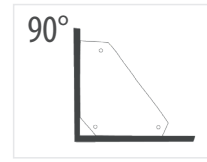
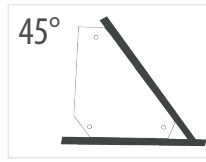

## MAGNETIC D50.90

Intercambiable

- Ángulo:  $\sphericalangle$  90°
- $\overset{\text{máx}}{\text{kg}}$  50 kg
- $\overset{\text{mm}}{\text{mm}}$  71 x 60 x 48
- $\text{x1}$



047075

## MAGNETIC D70.90 M

Intercambiable

- Ángulo:  $\sphericalangle$  90°
- $\overset{\text{máx}}{\text{kg}}$  70 kg
- $\overset{\text{mm}}{\text{mm}}$  48 x 32 x 70
- $\text{x1}$



047068

## MAGNETIC D70.120M

Intercambiable

- Ángulo:  $\sphericalangle$  45°, 60°, 75°, 90°, 105° & 135°
- $\overset{\text{máx}}{\text{kg}}$  70 kg
- $\overset{\text{mm}}{\text{mm}}$  111 x 55 x 80
- $\text{x1}$



047082

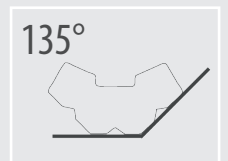
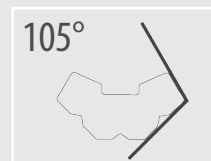
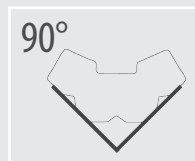
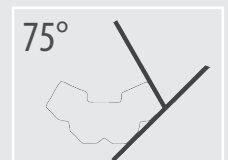
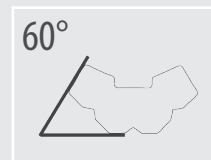
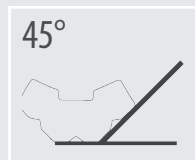

## MAGNETIC D70.135M

Intercambiable

- Ángulo:  $\sphericalangle$  45°, 75°, 90°, 105° & 135°
- $\overset{\text{máx}}{\text{kg}}$  70 kg
- $\overset{\text{mm}}{\text{mm}}$  99 x 55 x 80
- $\text{x1}$



047099

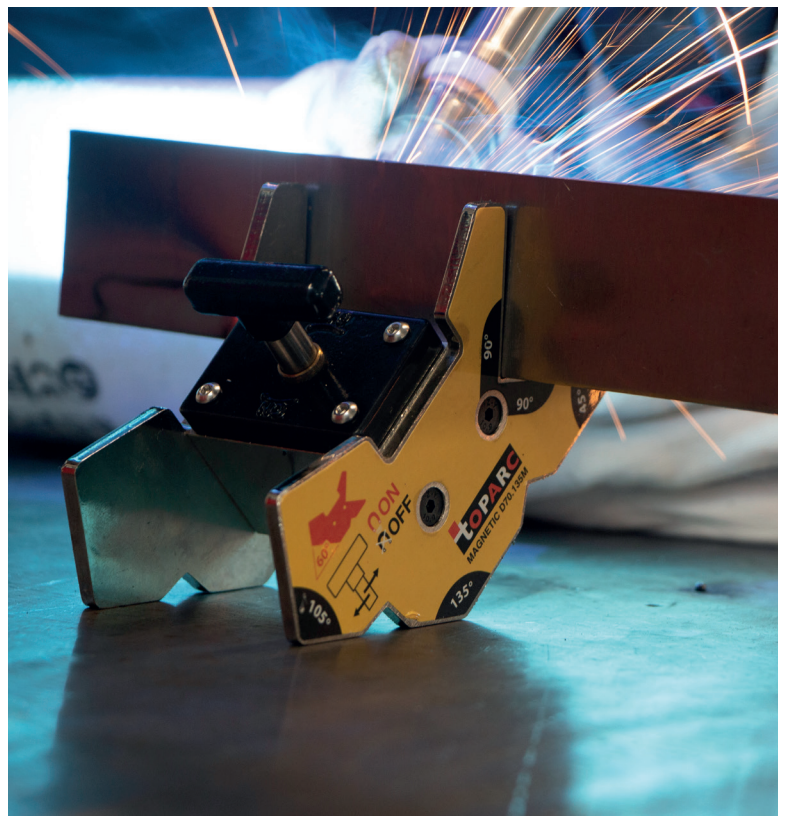
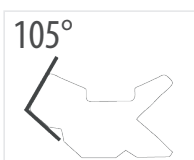
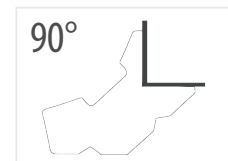
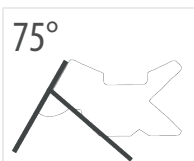
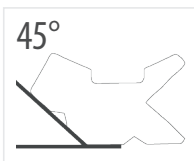



 **GYS Francia (HQ)**

1, rue de la Croix des Landes  
CS 54159  
53941 SAINT-BERTHEVIN Cedex  
Laval – Francia  
Fax : (+33) 2 43 68 35 21  
[www.gys.fr](http://www.gys.fr) / E-mail : [contact@gys.fr](mailto:contact@gys.fr)