



Produttore francese
da 1964

www.gys.fr



POSIZIONATORI MAGNETICI

Per avere più comfort durante le vostre saldature



Dei posizionatori magnetici per il comfort del saldatore

MAGNETIC P 15.90

- Angolo : 60° & 90°
- \downarrow max 15 kg
- \downarrow mm 100 x 73 x 12
- \downarrow x2



047044

MAGNETIC P 16.90

- Angolo : 45°, 90° & 135°
- \downarrow max 16 kg
- \downarrow mm 45 x 32 x 28
- \downarrow x4

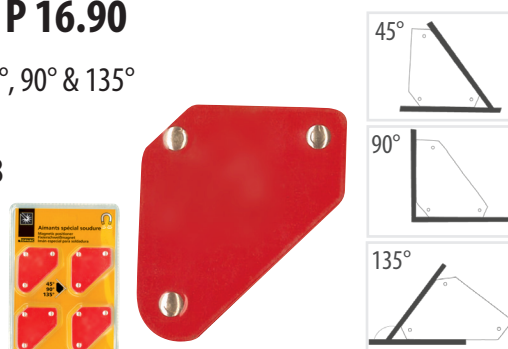

044180

MAGNETIC P 19.90

- Angolo : 45°, 90° & 135°
- \downarrow max 19 kg
- \downarrow mm 156 x 102 x 20
- \downarrow x1

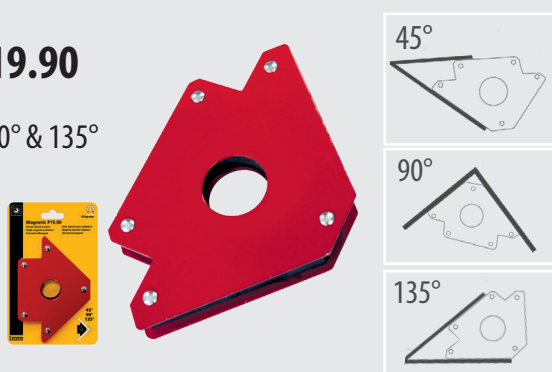

044203

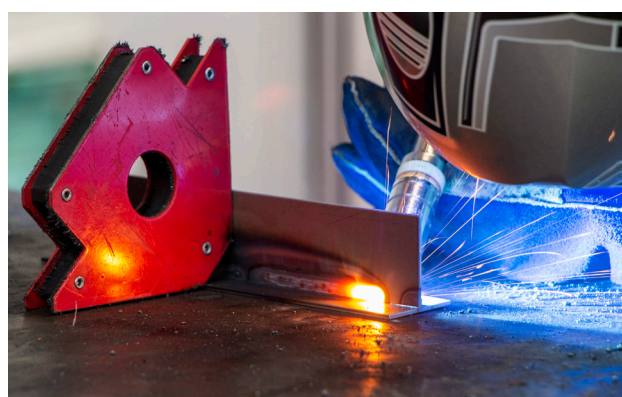

MAGNETIC P 20.180

- \downarrow 0 > 180°
- \downarrow max 20 kg
- \downarrow mm 204 x 86 x 28
- \downarrow x1



044302

MAGNETIC D50.90 DUAL Switchable

- Angolo : 90°
- \downarrow max 50 kg
- \downarrow mm 148 x 148 x 38
- \downarrow x1



047051

MAGNETIC D36.90

Switchable

- Angolo : 45°, 90° & 135°
- $\overset{\text{max}}{\text{kg}}$ 30 kg
- $\overset{\text{mm}}{\text{mm}}$ 111 x 95 x 25
- x1

044197

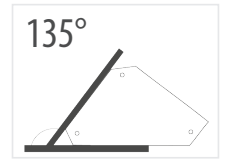
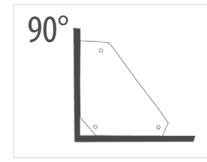
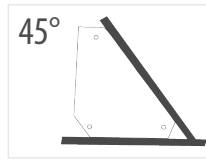

MAGNETIC D50.90

Switchable

- Angolo : 90°
- $\overset{\text{max}}{\text{kg}}$ 50 kg
- $\overset{\text{mm}}{\text{mm}}$ 71 x 60 x 48
- x1

047075



MAGNETIC D70.90 M

Switchable

- Angolo : 90°
- $\overset{\text{max}}{\text{kg}}$ 70 kg
- $\overset{\text{mm}}{\text{mm}}$ 48 x 32 x 70
- x1

047068



MAGNETIC D70.120M

Switchable

- Angolo : 45°, 60°, 75°, 90°, 105° & 135°
- $\overset{\text{max}}{\text{kg}}$ 70 kg
- $\overset{\text{mm}}{\text{mm}}$ 111 x 55 x 80
- x1

047082

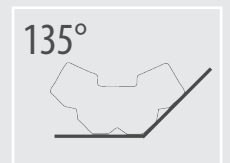
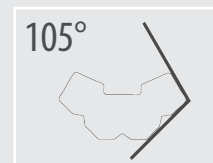
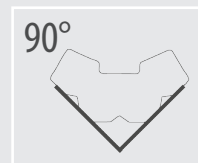
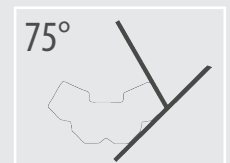
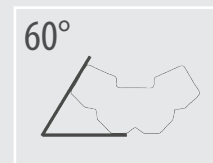
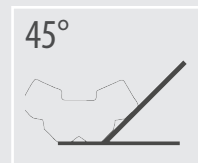

MAGNETIC D70.135M

Switchable

- Angolo : 45°, 75°, 90°, 105° & 135°
- $\overset{\text{max}}{\text{kg}}$ 70 kg
- $\overset{\text{mm}}{\text{mm}}$ 99 x 55 x 80
- x1

047099

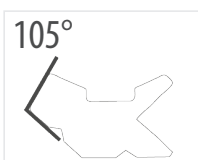
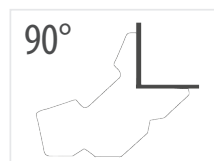
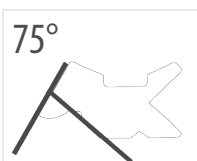



Creata nel 1964, GYS è un gruppo industriale francese che raggruppa più di 700 collaboratori nel mondo. Forte di un centro di ricerca di primo piano, GYS è un attore principale nella concezione e fabbricazione di attrezzature di saldatura, di caricabatterie e di sistemi di riparazione per le carrozzerie.

 **GYS Italia**

Via Porta Est, 7
30020 Marcon
VE
Italia

Tel : (+39) 041 53 21 565
E-mail : italia@gys.fr