



Fabricante industrial
francês desde 1964

www.gys.fr



POSITIONADORES MAGNÉTICOS

Para mais conforto na soldadura

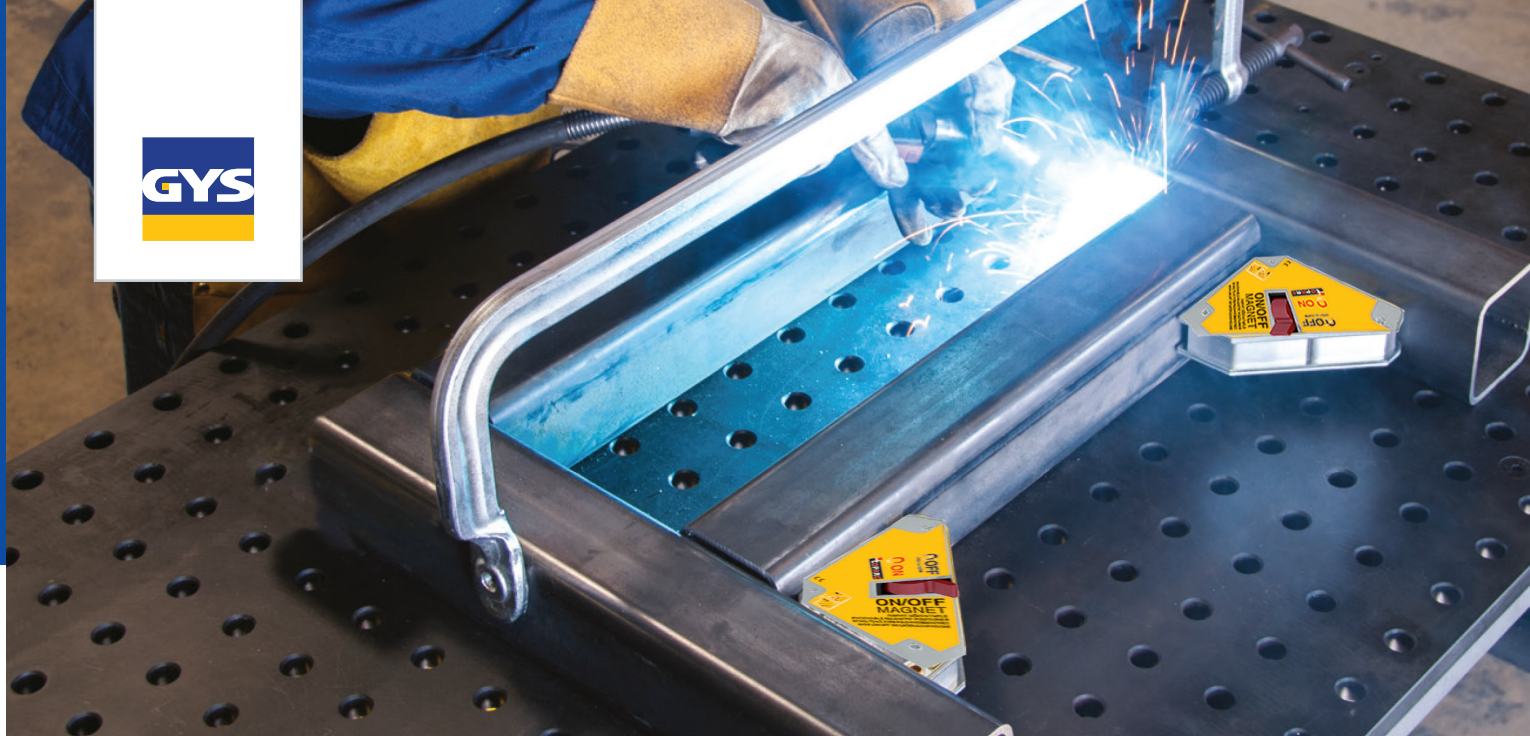

Posicionadores magnéticos para conforto dos soldadores

MAGNETIC P 15.90

- Ângulo : \sphericalangle 60° & 90°
- kg_{max} 15 kg
- mm 100 x 73 x 12
- x2



047044

MAGNETIC P 16.90

- Ângulo : \sphericalangle 45°, 90° & 135°
- kg_{max} 16 kg
- mm 45 x 32 x 28
- x4

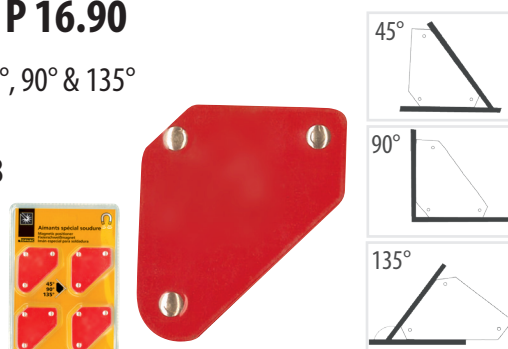

044180

MAGNETIC P 19.90

- Ângulo : \sphericalangle 45°, 90° & 135°
- kg_{max} 19 kg
- mm 156 x 102 x 20
- x1

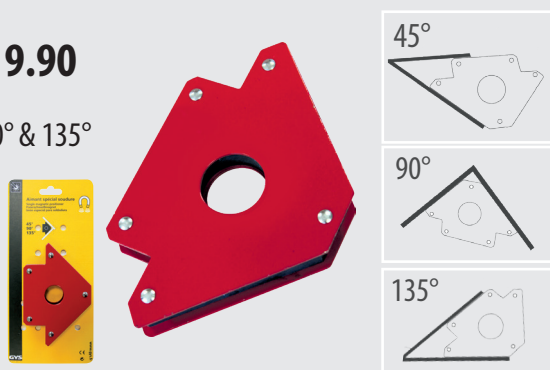

044203



MAGNETIC P 20.180

- $0 > 180^\circ \sphericalangle$
- kg_{max} 20 kg
- mm 204 x 86 x 28
- x1



044302

MAGNETIC D50.90 DUAL Trocável

- Ângulo : \sphericalangle 90°
- kg_{max} 50 kg
- mm 148 x 148 x 38
- x1



047051

MAGNETIC D36.90

Trocável

- Ângulo : \sphericalangle 45°, 90° & 135°
- kg_{max} 30 kg
- mm 111 x 95 x 25
- x1

044197

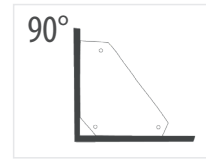
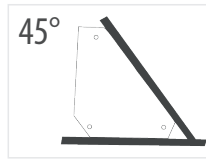

MAGNETIC D50.90

Trocável

- Ângulo : \sphericalangle 90°
- kg_{max} 50 kg
- mm 71 x 60 x 48
- x1

047075



MAGNETIC D70.90 M

Trocável

- Ângulo : \sphericalangle 90°
- kg_{max} 70 kg
- mm 48 x 32 x 70
- x1

047068



MAGNETIC D70.120M

Trocável

- Ângulo : \sphericalangle 45°, 60°, 75°, 90°, 105° & 135°
- kg_{max} 70 kg
- mm 111 x 55 x 80
- x1

047082

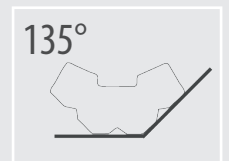
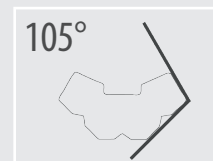
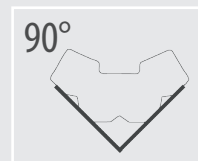
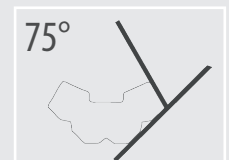
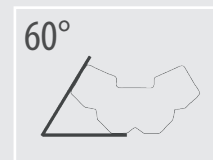
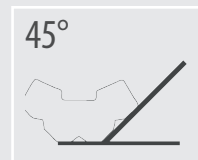

MAGNETIC D70.135M

Trocável

- Ângulo : \sphericalangle 45°, 75°, 90°, 105° & 135°
- kg_{max} 70 kg
- mm 99 x 55 x 80
- x1

047099

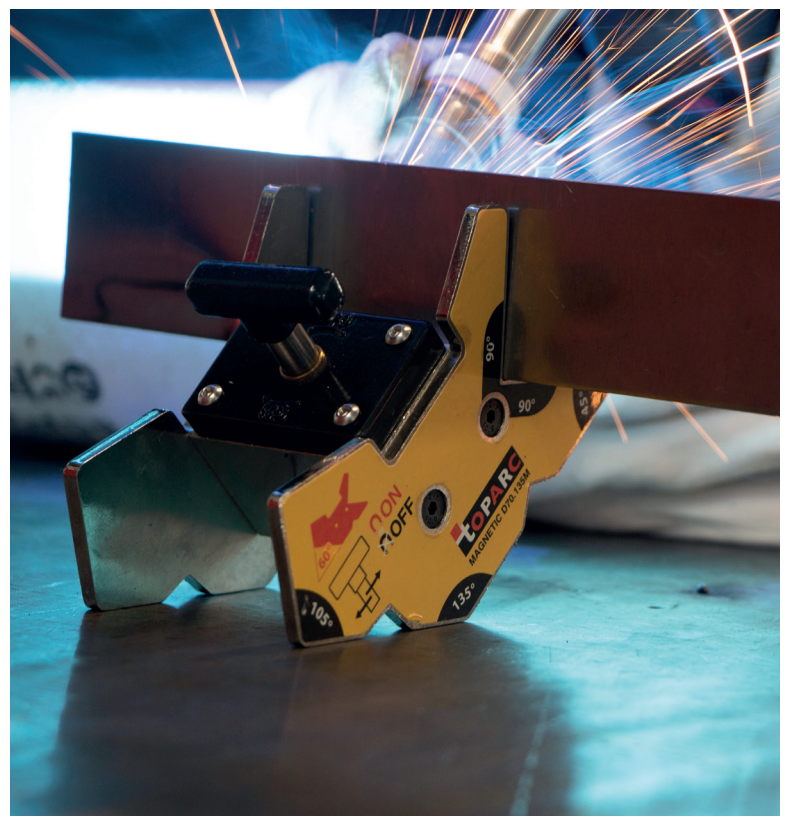
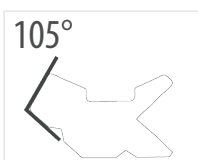
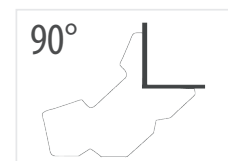
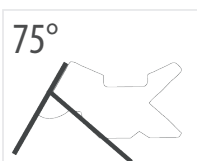



 **GYS France (HQ)**

1, rue de la Croix des Landes

CS 54159

53941 SAINT-BERTHEVIN -Cedex

Laval – França

Fax : (+33) 2 43 68 35 21

www.gys.fr / E-mail : contact@gys.fr